



EN



IMPACT PROTECTION SYSTEMS - 2025 -

## **Elektron Metalworks**

We specialize in designing precision-engineered and customized metalwork solutions for industrial, and commercial clients. Our services extend beyond the Polish market to include Europe and other international regions.

## **CUSTOM HOOP BARRIERS & BOLLARD POSTS**

**BY ELEKTRON SP. Z O.O.**

# ABOUT US

## Comprehensive manufacturing of projects based on customer concepts.

We are a group providing comprehensive services in metalworking. We offer a varied range of custom metal processing services, including the production of furniture parts, store display fixtures, and architectural products. We can become your trusted supplier for manufacturing services in the EU market.

### Certificates

Elektron sp. z o.o. operates a quality management system certified to ISO 9001, ISO 1090 EXC3, and ISO 3834 standards, ensuring the delivery of high-quality services through efficient processes and procedures.



**EN 1090-1+A1**

LL-C (Certification)



**EN ISO 3834-2**

LL-C (Certification)



**ISO 9001**

LL-C (Certification)



### OUR EXPERIENCE

Elektron has 7 years of market experience in manufacturing steel components and combining them with non-steel materials.



### END-TO-END SERVICE

A comprehensive overview of the process, from initiation to completion.



### PLANT & MACHINERY

We invest in experienced personnel, modern equipment and technology.



### ORGANIZATION AND WORK CULTURE

We focus on high work organization to deliver quality products while minimizing unnecessary costs. Our goal is to offer our customers mutually beneficial cooperation.

## Elektron sp. z o.o.

**Address:** Sulistrowa 33, 38-462 Sulistrowa,

Poland

**Email:** [biuro@web-elektron.pl](mailto:biuro@web-elektron.pl)

**Phone:** (+48) 13 307 0303

**VAT:** PL6842640074

**REGON:** 360939126

**KRS:** 0001022315



[webelektron.com](http://webelektron.com)

## CONTENTS

- **Steel Bollards**
- **Linear Hoop Protection Guard**
- **Steel Floor Rail**
- **Double hoop safety barriers**
- **Corner Tubular Protection**
- **U-type fenders Buffers**
- **Column & Post protectors**
- **Warehouse collision protection bars**
- **Pallet Racking Protectors**
- **Wheel guides**
- **Height limiters and gate protection**

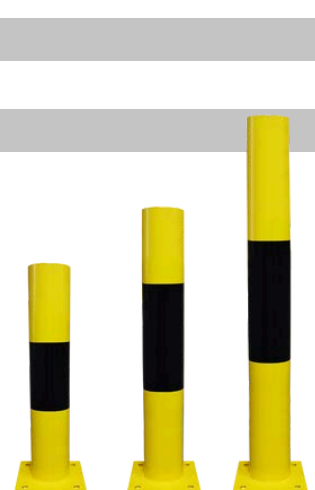

# WE OFFER: BOLLARDS & BARRIERS

We provide a comprehensive process that encompasses every stage, from concept and production to delivery, all within a single entity. Our commitment is to offer the best possible experience for our customers, underpinned by exceptional industry expertise and superior quality.



**BOLLARD POSTS**



**SAFETY HOOP BARRIER**



**DOUBLEHOOP**



**L - CORENR PROTECTION HOOPS**



**U - DOUBLAE CORNER PROTECTION HOOPS**



**COLUMN COLLISION PROTECTION**



**PALLET RACKING**



**COLLISION PROTECTION CROSSBAR**



**HEIGHT RESTRICTION BARRIERS**



**WHEEL GUIDES**



Our metal protective posts, with **diameters ranging from Ø42,4** and **heights from 30cm** are specifically designed to protect doorways, corners, and equipment, while ensuring high visibility.

These posts are coated with a layer of zinc and painted in bright yellow for maximum attention. Additional black stripes further enhance their visibility.

*We also offer custom-made guardrails tailored to your needs. Please contact us if you require posts of different sizes, materials, colors, or designs.*

**Key features:**

- Material: black steel
- Coating: hot-dip galvanized and powder coated yellow with black stripes, or for indoor use only powder coated yellow with black reflective stripes
- Mounting: fixing to the ground with screws or anchors
- Base thickness: 6-15 mm

## STEEL BOLLARDS

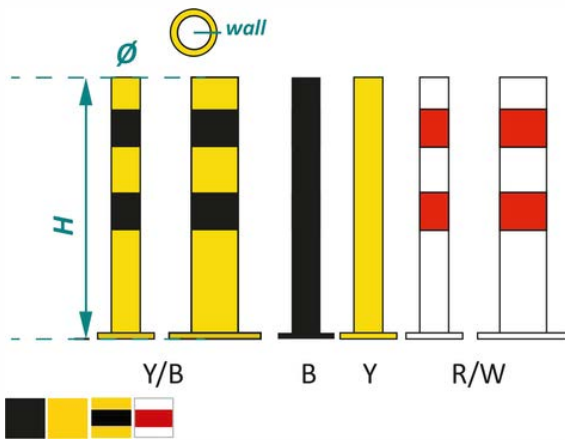

	Ø (mm)	H (mm)
SB01	48,3	300,600,800, 900,1000,1200
SB02	60,3	
SB03	76,1	
SB04	114,3	
SB05	159	
SB06	219,1	

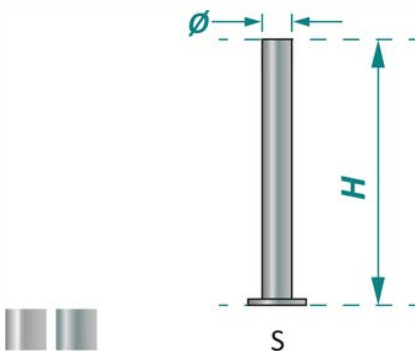

## STAINLESS STEEL BOLLARDS

	Ø (mm)	H (mm)
SSB01	42,4	250
SSB02	42,4	500
SSB03	42,4	800



# TUBULAR PROTECTION BARRIERS

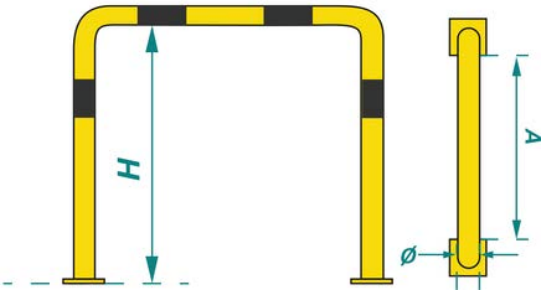

**TP-L**

	Ø (mm)	H (mm)	A (mm)
TP-L01	42,4	600,800,1000,1200	400,500,600,700, 800,900, 1000,1200, 1500,2000
TP-L02	48,3		
TP-L03	60,3		
TP-L04	76,1		

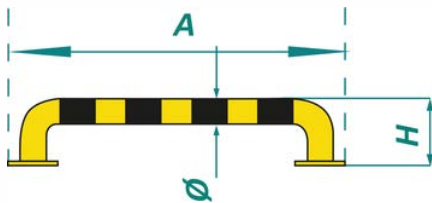

**TP-S**

	Ø (mm)	H (mm)	A (mm)
TP-S01	48,3	180, 220, 300, 400	300,350,400,450, 500,600,800,1000, 1200,1500,2000, 3000
TP-S02	60,3		
TP-S03	76,1		
TP-S04	114,3		

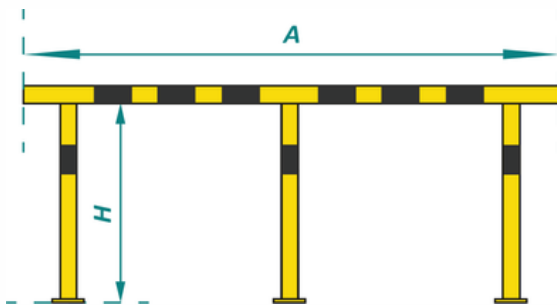

**TP-H**

	Ø (mm)	H (mm)	A (mm)
TP-H01	48,3	600,800, 1000,1200	300,350,400,450, 500,600,800,1000, 1200,1500,2000, 3000
TP-H02	60,3		
TP-H03	76,1		
TP-H04	114,3		

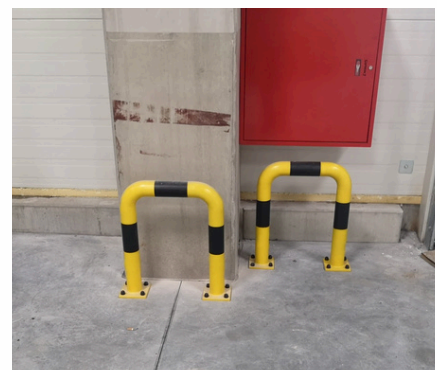

## STEEL FLOOR RAIL

### SFS - Shop fender stainless steel

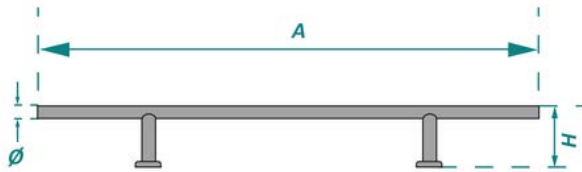

	Ø (mm)	H (mm)	A (mm)
SFS01	42,4	180	400, 500, 600, 1200, 1600
SFS02			
SFS03			
SFS04			

### CFS - Corner shop fender stainless steel

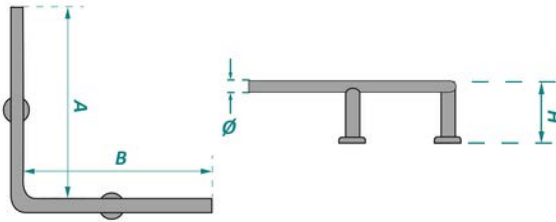

	Ø (mm)	H (mm)	A (mm)	B (mm)
CFS01	42,4	180	400	400
CFS02	42,4	180	600	600

## DOUBLE HOOP SAFETY BARRIERS

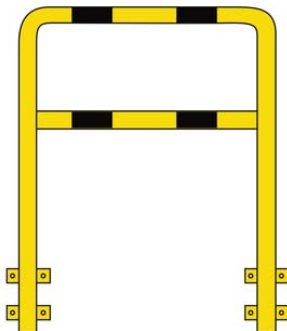
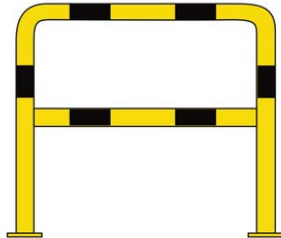

### (DH) - double hoop

	Ø (mm)	H (mm)	A (mm)
DH01	42,4	600, 800, 1000, 1200	400, 500, 600, 700, 800, 900, 1000, 1200, 1500, 2000
DH02	48,3		
DH03	60,3		
DH04	76,1		

### (F-DH) - Permanent wall fix double hoop

	Ø (mm)	H (mm)	A (mm)
F-DH01	42,4	600, 800, 1000, 1200	400, 500, 600, 700, 800, 900, 1000, 1200, 1500, 2000
F-DH02	48,3		
F-DH03	60,3		
F-DH04	76,1		



# CORNER TUBULAR PROTECTION

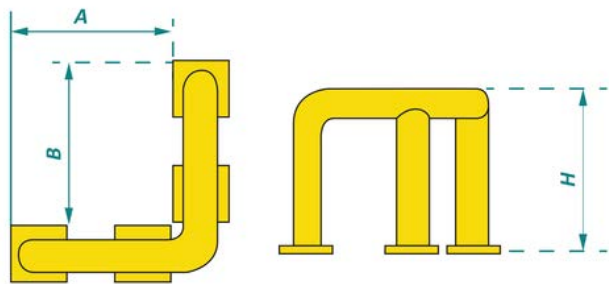

(L-1) - L storage buffers

	Ø (mm)	H (mm)	A=B (mm)
L-101	42,4	300,600,800,1000,1200	300,400,500,600,700,800,900,1000,1200,1500
L-102	48,3		
L-103	60,3		
L-104	76,1		

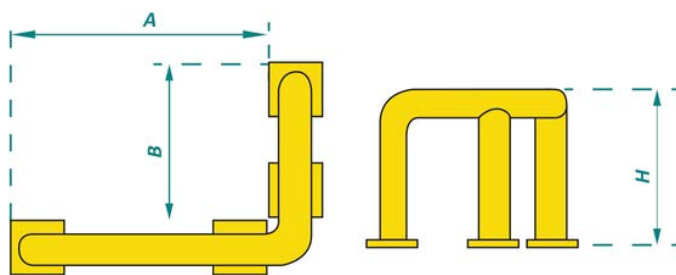

(L-2) - L storage buffers

	Ø (mm)	H (mm)	A (mm)	B (mm)
L-201	42,4	300,600,800,1000,1200	300,400,500,600,700,800,900,1000,1200,1500	300,400,500,600,700,800,900,1000,1200,1500
L-202	48,3			
L-203	60,3			
L-204	76,1			

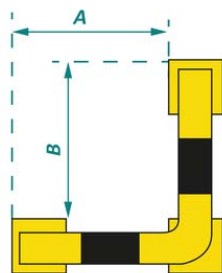

(L-3) - Corner collision protection bar

	Ø (mm)	H (mm)	A/B (mm)
L-301	42,4	300,600,800,1000,1200	300,400,500,600,700,800,900,1000,1200,1500
L-302	48,3		
L-303	60,3		
L-304	76,1		

# U-TYPE FENDERS BUFFERS



(U-1) - U-type fenders Buffers - Two legs

	Ø (mm)	H (mm)	A (mm)	B (mm)
U-101	42,4	300,600,800,1000,1200	300,400,500,600,700,800,900,1000,1200,1500	300,400,500,600,700,800,900,1000,1200,1500
U-102	48,3			
U-103	60,3			
U-104	76,1			

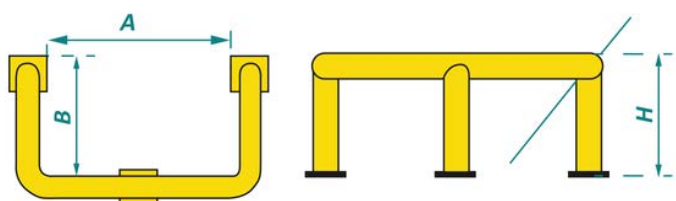

(U-2) - U-type fenders Buffers - Three legs

	Ø (mm)	H (mm)	A (mm)	B (mm)
U-201	42,4	300,600,800,1000,1200	300,400,500,600,700,800,900,1000,1200,1500	300,400,500,600,700,800,900,1000,1200,1500
U-202	48,3			
U-203	60,3			
U-204	76,1			

**(U-3) - U-type fenders Buffers - Four legs**

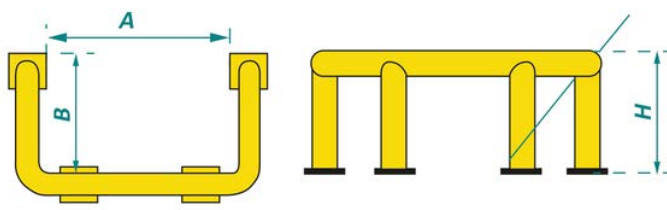

	Ø (mm)	H (mm)	A (mm)	B (mm)
U-301	42,4	300,600,800,1000,1200	300,400,500,600,700,800,900,1000,1200,1500	300,400,500,600,700,800,900,1000,1200,1500
U-302	48,3			
U-303	60,3			
U-304	76,1			



**COLUMN & POST PROTECTORS**

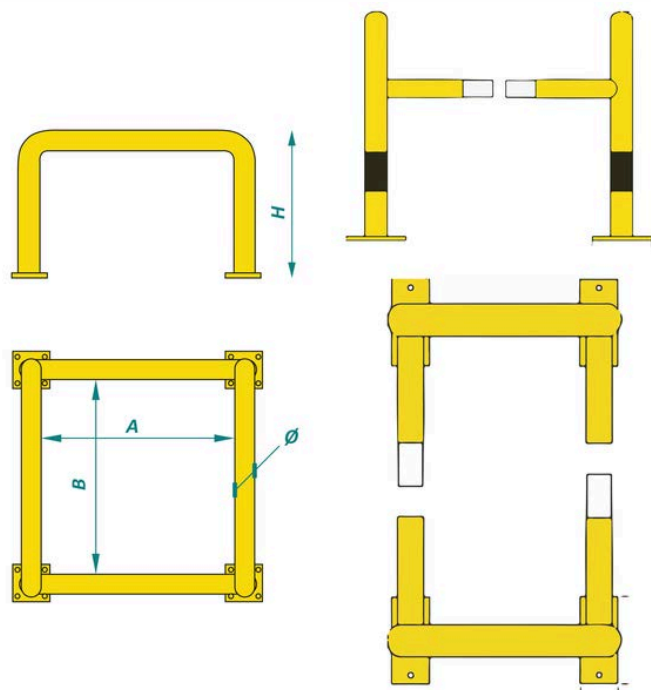

	Ø (mm)	H (mm)	A=B (mm)
CPP-01	42,4	600,800,1000,1200	600,800,1000
CPP-02	48,3		
CPP-03	60,3		
CPP-04	76,1		





# WAREHOUSE COLLISION PROTECTION BARS

## (CPB) - Collision protection bars

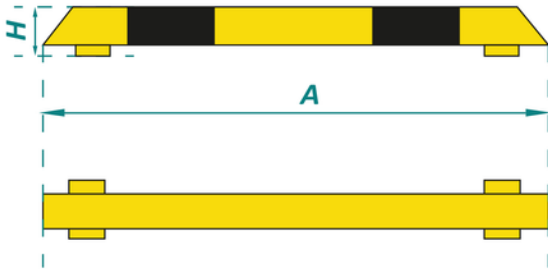

	Ø (mm)	A (mm)
CPB-101	42,4	300,600,800,1000,1200
CPB-102	48,3	
CPB-103	60,3	
CPB-104	76,1	



## PALLET RACKING PROTECTORS

### (RG-PR) - Right-angle: Two way protection.

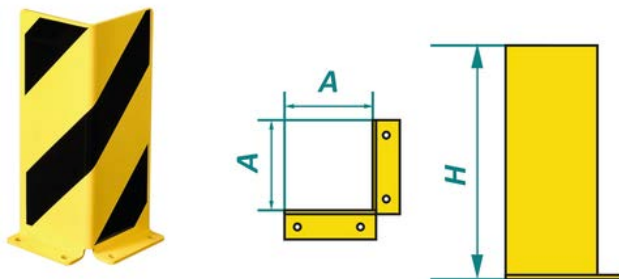

	H (mm)	A (mm)
RG-PR	400,500,600, 800,1000,1500	300,600,800, 1000,1200

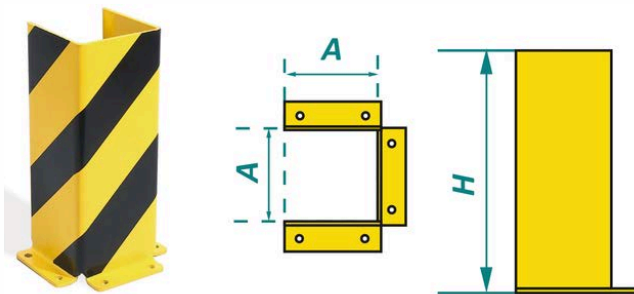

### (UP-PR) - U-profile: Three way protection.

	H (mm)	A (mm)
UP-PR	400,500,600, 800,1000,1500	300,600,800, 1000,1200

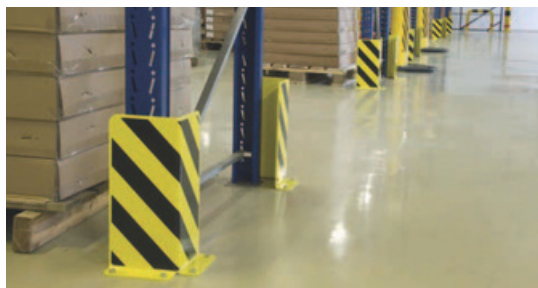



## WHEEL GUIDES

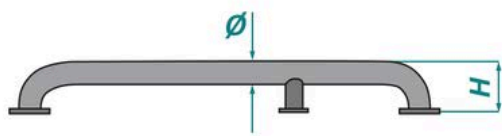
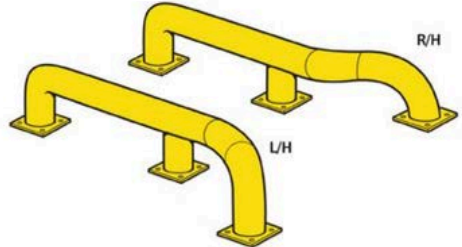
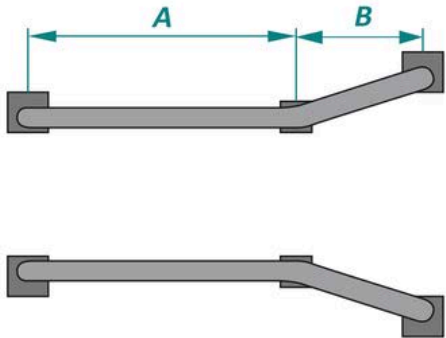

(WG)

	$\varnothing$ (mm)	H (mm)	A+B (mm)
WG01	76,1	300	1500,2000, 2500,3000
WG02	114,3		
WG03	159		

## HEIGHT LIMITERS AND GATE PROTECTION



(HL)

	$\varnothing$ (mm)	A (mm)
HL01	42,4	500,1000,1500, 2000,2500,3000
HL02	48,3	
HL03	60,3	



ELEKTRON SP. Z O.O.

# BRINGING IDEAS TO LIFE WITH EXPERT METALWORKING



Sulistrowa 33, 38-462  
Poland



[biuro@web-elektron.pl](mailto:biuro@web-elektron.pl)



(+48) 13 307 03 03

[webelektron.com](http://webelektron.com)